

Greenhouse Assembly Instructions



6 x 8 GREENHOUSE 01 ASSEMBLY INSTRUCTIONS

6 x 6 GREENHOUSE 02 ASSEMBLY INSTRUCTIONS

6 x 4 GREENHOUSE 03 ASSEMBLY INSTRUCTIONS



Our Help Line provides support and advice to customers of Summer Garden Buildings after ordering. For advice before you buy you can phone us free 7 days a week on 0800 9777828 or visit www.summergardenbuildings.co.uk

Introduction

Safety

Precautions are required when assembling a greenhouse. The wearing of protective gloves and stout footwear is essential when handling glass and recommended even for polycarbonate which does not shatter but has sharp edges. Protective goggles are recommended whilst handling glass and the glazing spring clips. Assembly of the greenhouse frame is much easier with two people and essential for glazing with glass.

Site selection

Choose a site in maximum light, ideally with no direct shade. Avoid overhanging trees as much as possible as leaves will make regular cleaning necessary and broken branches are a potential hazard. Small trees, bushes or fences nearby can be helpful, acting as a wind break. A position close to the house will make access easier for watering and tending and also make it easier to supply power cables or automatic watering systems if required.

The site must be prepared so that the base of the greenhouse is level all round and checking with a spirit level is required.

Base options & construction

The use of purpose-made, galvanised steel bases is recommended. They are made to fit the greenhouses. It is easier to maintain a level and square foundation and they are easy to install, requiring little expertise. Full instructions are included in the pack.

Bases can also be constructed from bricks, blocks, or mounted on a concrete pad. The bricks or blocks should be cemented onto firm and level concrete footings and the greenhouse frame drilled and screwed to the base. **Fig3.**

If a concrete pad is made, it is important that this slopes towards the edges to prevent water ingress. Time must be allowed for any concrete or cement to cure before mounting the greenhouse.

The base must be square or the greenhouse will be distorted - see **Fig1 & Fig2.** The greenhouse must be firmly fixed to the ground. The base should be constructed and installed before the greenhouse assembly is undertaken.

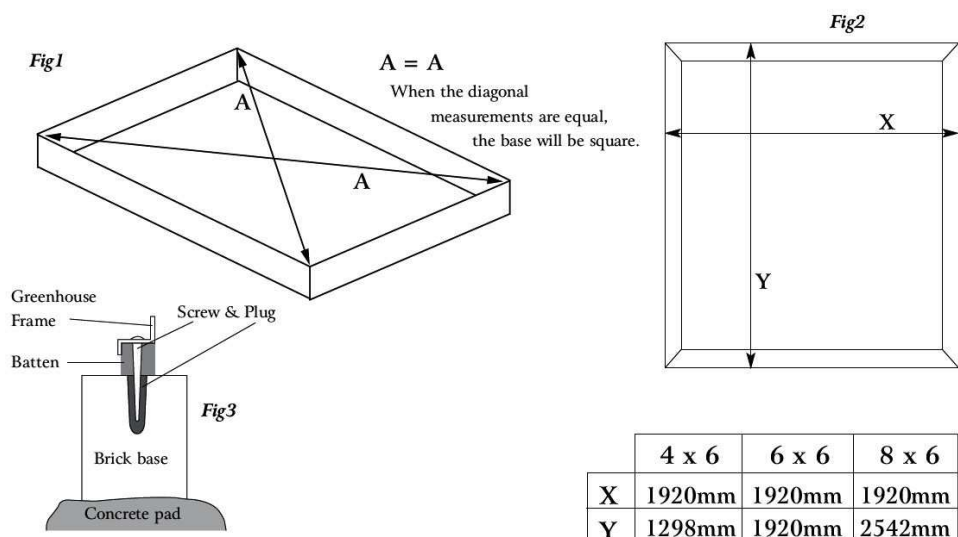

Our Help Line provides support and advice to customers of Summer Garden Buildings after ordering. For advice before you buy you can phone us free 7 days a week on 0800 9777828 or visit www.summergardenbuildings.co.uk

Before you start read the instructions completely

Construct the base first so that the greenhouse can be securely mounted when completed.

Find someone to help you. It is much easier with someone to hold parts, pass tools etc. This is not very heavy work so it would suit most able-bodied people.

Allow plenty of time. Rushing often causes errors and doing things again. If you have never built a greenhouse before, it can take the best part of a day to complete the construction with care.

Have the right tools to hand:

- Cross head and flat head screwdrivers
- 10mm spanner
- Safety clothing as recommended in the 'Safety' section.

Lay out the parts by greenhouse section, ideally around the base as shown, and check that all are present before commencing construction. Lay on cloth or plastic sheets if there is any risk of scratching the parts.

Follow this construction sequence.

- Side sections
- Back section
- Front section
- Frame assembly and roof
- Door
- Vent (if applicable)
- Glazing

All illustrations are based on viewing the parts from the inside of the greenhouse, except where stated.

Assemble the greenhouse loosely where possible and tighten when all in place so that minor adjustments can be made. Note that some nuts will need to be tightened to keep them in place.

Tighten all nuts carefully, being sure not to miss any. Check the frame is square and using a spirit level to check that it is upright.

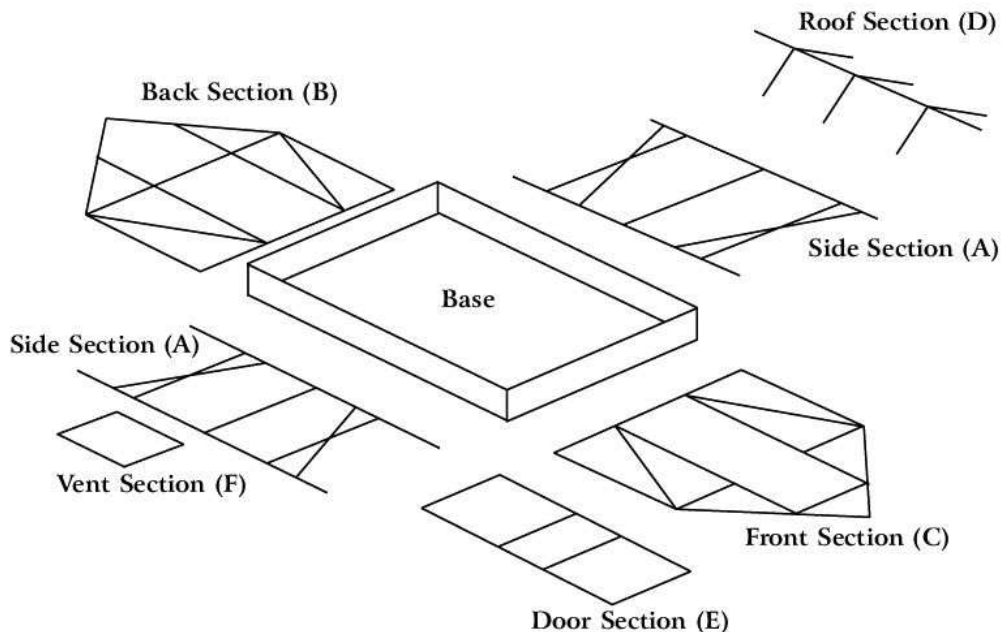

Our Help Line provides support and advice to customers of Summer Garden Buildings after ordering. For advice before you buy you can phone us free 7 days a week on 0800 9777828 or visit www.summergardenbuildings.co.uk







Frame Components

Profile	Position (viewed from inside)	4x6 House	6x6 House	8x6 House	Description	Code
	Bottom bars	2			side - lower horizontals (4ft)	A1-4
			2		side - lower horizontals (6ft)	A1-6
				2	side - lower horizontals (8ft)	A1-8
	Gutter bars	2			side - upper horizontals (4ft)	A2-4
			2		side - upper horizontals (6ft)	A2-6
				2	side - upper horizontals (8ft)	A2-8
	Verticals	2	4	6	side glazing uprights	A3
	Sides	2	4	4	Diagonal braces - multi use	G1
	Back	2	2	2		
	Front	2	2	2		
	Bottom bar	1	1	1	Back - lower horizontal	B1
	Mid height	1	1	1	Back - horizontal brace	B2
	Back Left	1	1	1	Back glazing verticals	B3-1
	Back Right	1	1	1		B3-2
	Back Left	1	1	1	Roof edge bars	B4-1
	Back Right	1	1	1		B4-2
	Back	2	2	2	Corner verticals	H1
	Front	2	2	2		
	Base bar	1	1	1	Front - lower horizontal	C1
	Door frame top	1	1	1	Door frame horizontal	C2
	Left	1	1	1	Front uprights (Door Jams)	C3-1
	Right	1	1	1		C3-2
	Front left	1	1	1	Roof edge Beams	C4-1
	Front right	1	1	1		C4-2
	Door frame top	1	1	1	Door runner	C5
	Mid height	2	2	2	Front horizontal braces	C6
	Roof apex	1			Ridge bar	D1-4
			1			D1-6
				1		D1-8
	Roof sides	2	4	6	Roof glazing bar	D3
	Door sides	2	2	2	Door verticals	E1
	Door top	1	1	1	Door - upper horizontal	E2
	Door bottom	1	1	1	Door - lower horizontal	E3
	Door middle bars	2	2	2	Door - mid horizontal	E4























Our Help Line provides support and advice to customers of Summer Garden Buildings after ordering. For advice before you buy you can phone us free 7 days a week on 0800 9777828 or visit www.summergardenbuildings.co.uk

Frame Components (continued)

Profile	Position (viewed from inside)	4x6 House	6x6 House	8x6 House	Description	Code
	Door top bar	1	1	1	Door runner housing	E5
	Front corner	1	1	1	Door runner support arm	E6
	Between roof bars	0	1	1	Vent mounting bar	F1
	Window top	0	1	1	Vent top bar	F2
	Window front	0	1	1	Vent bottom bar	F3
	Window sides	0	2	2	Vent side bars	F4

Other Components

Profile	Position (viewed from inside)	4x6 House	6x6 House	8x6 House	Description	Size (mm)	Code
	Upper corners inside	4	4	4	Corner plate		G2
	Door frame top corners	2	2	2	Door runner mount	15	E9
	Ends of CV's and RG's	8	8	8	Profile end caps		G3
	Door horizontals	16	16	16	Door screws	No 6x19	619
	Runner wheels	2	2	2	Door runner bolts	M4x16	M416
		2	2	2	Nut for M4	M4	M4-1
		2	2	2	Washer for M4	M4	M4-2
	DRS to spacer	1	1	1	Door spacer bolt	M6x40	M640
		1	1	1	Nuts for M6	M6	M6-1
	Inside door frame	2	2	2	Door seal	1610	E10
	Door bottom	2	2	2	Door base sliders		E11
	Door top	2	2	2	Door running wheel		E12
	Free end of Door runner	1	1	1	Door gear spacer		E13
	Vent bottom bar	0	1	1	Vent stay		F10
	Vent horizontal Mount	0	2	2	Vent catch		F12
		0	6	6	Vent catch screws	No6x6	66
	Clips into glazing bars	144	172	204	Glazing spring clip		G4
	All glazing bars	45m	54m	64m	Rubber glazing bead		G5
		4	4	4	Gutter end caps		A20
		74	94	102	Bolts	M6x10	M610
		74	94	102	Nuts for M6	M6	M6-1



Our Help Line provides support and advice to customers of Summer Garden Buildings after ordering. For advice before you buy you can phone us free 7 days a week on 0800 9777828 or visit www.summergardenbuildings.co.uk

A) GREENHOUSE SIDES

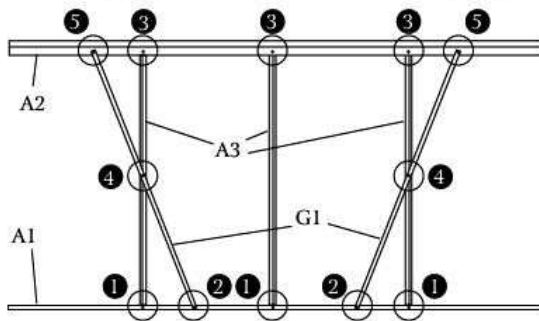
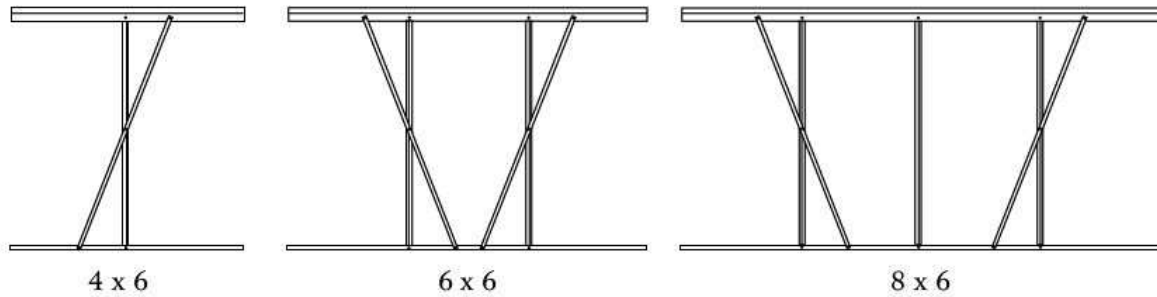

Profile	Code	4x6	6x6	8x6
	A1	2	2	2
	A2	2	2	2
	A3	2	4	6
	G1	2	4	4
	M610 M6-1	Used for all sections so quantity not listed in this or other parts lists.		

Note: Although there are different greenhouse sizes, the steps are the same.

A1 and A2 are coded by Greenhouse size.
e.g. :-

(A1-4 = 4 x 6)
(A1-6 = 6 x 6)
(A1-8 = 8 x 6)

Introduction

Lay parts on the ground, as pictured at the top of this page. Assemble loosely with the nuts to the inside of the structure.

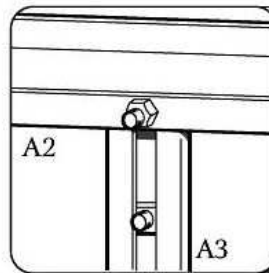

Step 3
Before bolting the glazing uprights to the outside of the top gutter bar, insert bolts into the channels for fixing the diagonal braces.

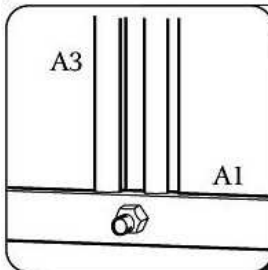

Step 1
Insert bolt into the channel in the upright (A3). Bolt glazing uprights to the outside of the bottom bar.

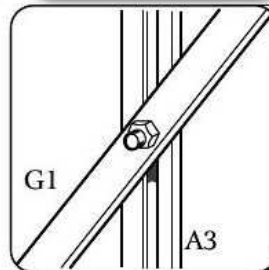

Step 4
Use the inserted bolts (see 3) to secure the diagonal braces to the uprights. Do not tighten yet.

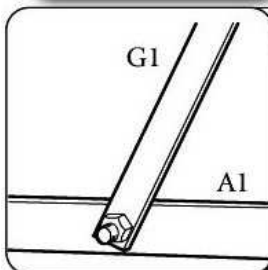

Step 2
Bolt diagonal braces to inside of bottom bar.
Note: the flat side of the bottom bar faces inwards.

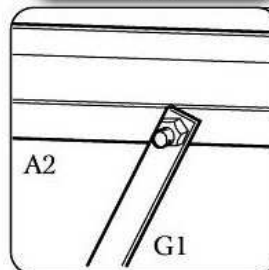

Step 5
Bolt the diagonal brace to the inside of the top gutter bar. Repeat for the other side of the Greenhouse.

Pictures are viewed from inside the greenhouse unless stated



Our Help Line provides support and advice to customers of Summer Garden Buildings after ordering. For advice before you buy you can phone us free 7 days a week on 0800 9777828 or visit www.summergardenbuildings.co.uk

B) GREENHOUSE BACK

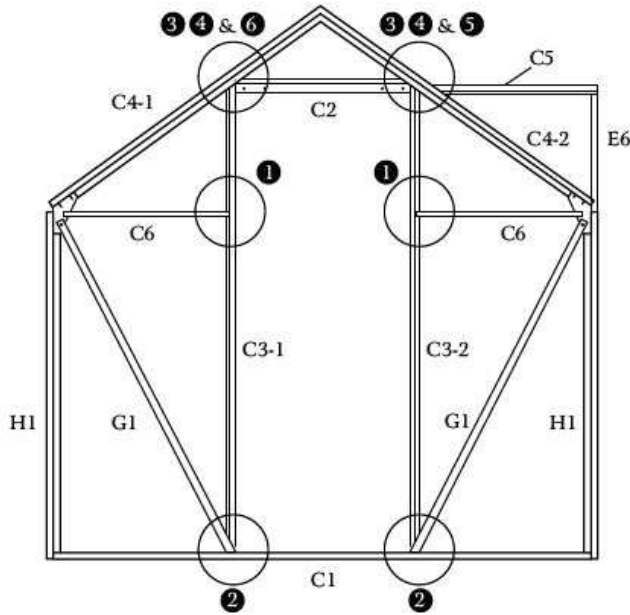

Profile	Code	4x6	6x6	8x6
	C1	1	1	1
	C2	1	1	1
	C3-1	1	1	1
	C3-2	1	1	1
	C4-1	1	1	1
	C4-2	1	1	1
	C5	1	1	1
	C6	2	2	2
	G1	2	2	2
	H1	2	2	2
	E6	1	1	1
	M640	1	1	1
	E13	1	1	1
	G2	2	2	2
	E9	2	2	2
	M610	Used for all sections so quantity not listed in this or other parts lists.		
	M6-1			

This section is the same for 8x6, 6x6 and 4x6 greenhouses.

Lay the parts on the ground as pictured and assemble loosely. Check that the corner verticals, glazing uprights and the roof bars are in the correct positions (left and right sides are different).

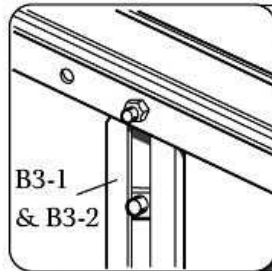

Step 4
Before bolting the glazing uprights to the outside of the roof bars, insert bolt into the channel for fixing the horizontal brace.

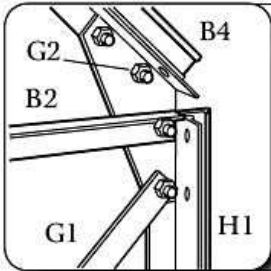

Step 1
Corner joint assembly: bolt the corner plates to the inside of the roof and vertical bars. Bolt the horizontal and diagonal braces inside the corner plates.

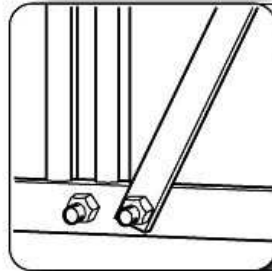

Step 5
Bolt the diagonal braces to the inside of the bottom bars.

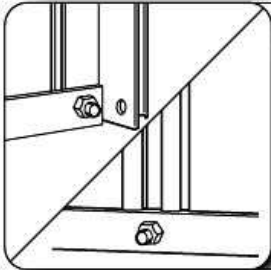

Step 2 & 3
Bolt bottom bars to corner and glazing verticals.
Note: the flat side of the bottom bar faces inwards.

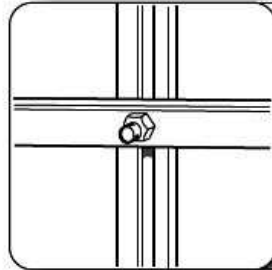

Step 6
Bolt the horizontal braces to the inside of the glazing uprights using the bolts inserted. See step 4.

Pictures are viewed from inside the greenhouse unless stated



Our Help Line provides support and advice to customers of Summer Garden Buildings after ordering. For advice before you buy you can phone us free 7 days a week on 0800 9777828 or visit www.summergardenbuildings.co.uk

C) GREENHOUSE FRONT

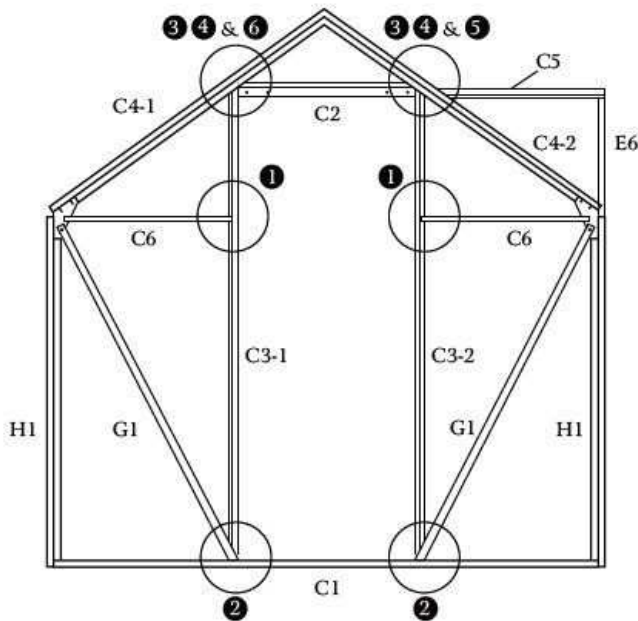

Profile	Code	4x6	6x6	8x6
	C1	1	1	1
	C2	1	1	1
	C3-1	1	1	1
	C3-2	1	1	1
	C4-1	1	1	1
	C4-2	1	1	1
	C5	1	1	1
	C6	2	2	2
	G1	2	2	2
	H1	2	2	2
	E6	1	1	1
	M640	1	1	1
	E13	1	1	1
	G2	2	2	2
	E9	2	2	2
	M610 M6-1	Used for all sections so quantity not listed in this or other parts lists.		

This section is the same for 8x6, 6x6 and 4x6 greenhouses.
Lay the parts on the ground as pictured and assemble loosely.
Check that the corner verticals and the roof bars are in the correct positions (left and right).
Assemble front end section in the same sequence as the back section, but note that: a) horizontal brace is in two sections b) door uprights replace the glazing uprights.

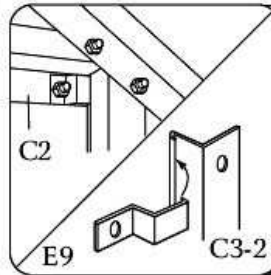

Step 4
Insert bolts from the outside through the door frame top bar and through the support clips (E9) and attach nut loosely. Hook support clips into groove in the door upright.

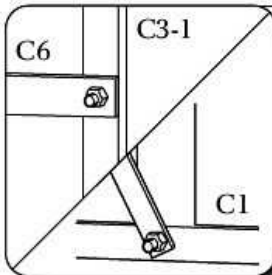

Step 1
Bolt the two middle horizontal braces to the inside of the door uprights.
Step 2
Note that the diagonal braces fit the same hole as the door uprights.

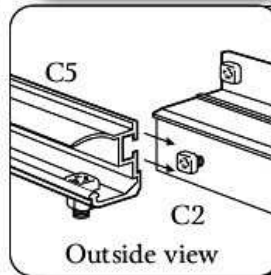

Step 5
Slide the door runner bar over the bolt heads and into position with the right hand edge flush with the door frame. Tighten nuts.
Step 6
Insert nut and bolt into the end hole of the door runner bar to act as a door stop.

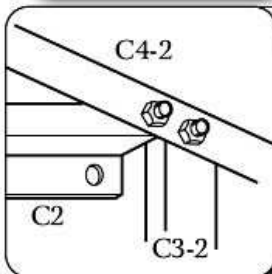

Step 3
Bolt the door frame top bar to the outside of the roof bars, left and right.

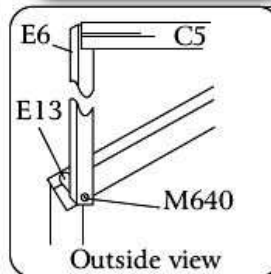

Fit the support arm E6 as shown. Use a bolt inserted into C5 at the top and bolt M640 and spacer E13 at the bottom.

Pictures are viewed from inside the greenhouse unless stated



Our Help Line provides support and advice to customers of Summer Garden Buildings after ordering. For advice before you buy you can phone us free 7 days a week on 0800 9777828 or visit www.summergardenbuildings.co.uk

D) GREENHOUSE ASSEMBLY & ROOF SECTION

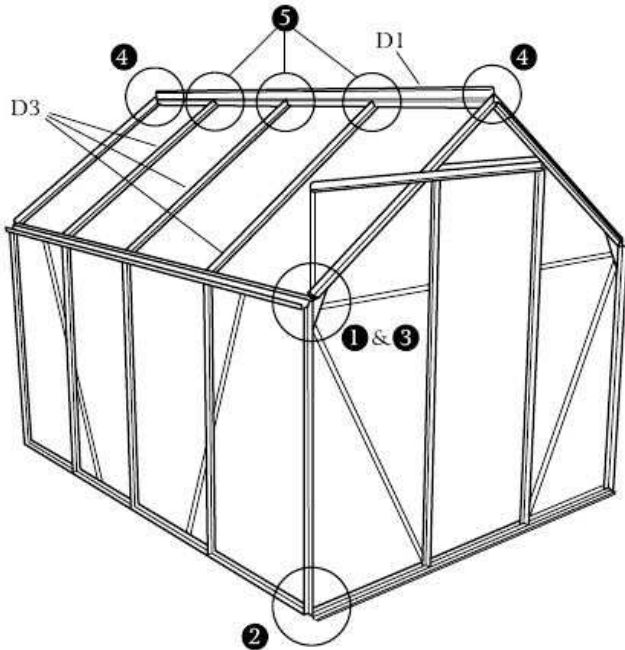

(D1-4 = 4 x 6)
 (D1-6 = 6 x 6)
 (D1-8 = 8 x 6)

Profile	Code	4x6	6x6	8x6
	D1	1	1	1
	D3	2	4	6
	G3	8	8	8
	M610 M6-1	Used for all sections so quantity not listed in this or other parts lists.		

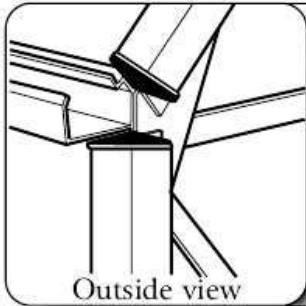

Step 1
 In this section, the four greenhouse walls are joined together and the roof added. This phase is best undertaken by two people. Fit the profile end caps to the roof and upright bars before assembly.

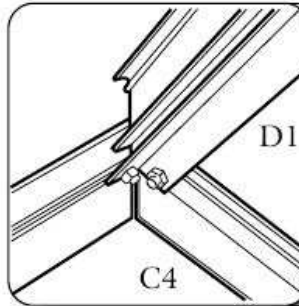

Step 4
 Bolt the ridge bar to the underside of the end roof bars as shown.

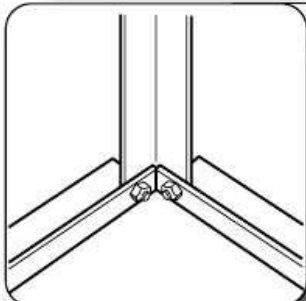

Step 2
 Bolt the bottom side and front bars to the inside of the corner post.

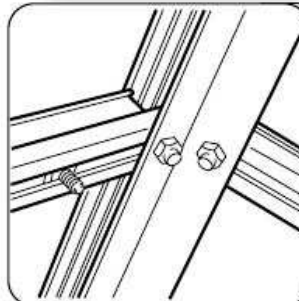

Step 5
 Bolt the roof glazing bars to the ridge and gutter bars, remembering to insert a pair of bolts into the channels where the vent is to be fitted (8x6 and 6x6 houses only).

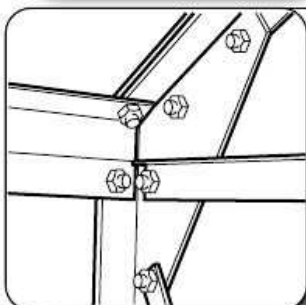

Step 3
 Bolt the gutter side bar to the inside of the corner section. Repeat 2 and 3 for all four corners.

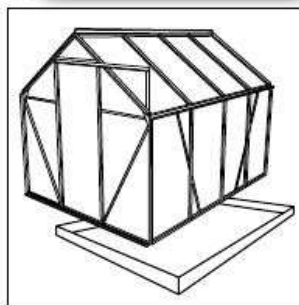

Lift the frame onto the prepared base and fix loosely. Check that the frame is square and sits nicely on the base before tightening all nuts.

Pictures are viewed from inside the greenhouse unless stated



Our Help Line provides support and advice to customers of Summer Garden Buildings after ordering. For advice before you buy you can phone us free 7 days a week on 0800 9777828 or visit www.summergardenbuildings.co.uk

E) GREENHOUSE DOOR ASSEMBLY

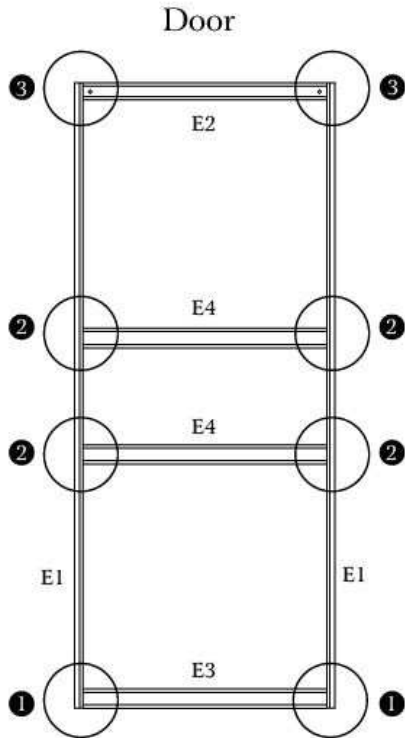

Assembly Parts

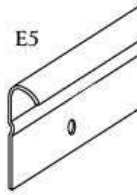

Profile	Code	4x6	6x6	8x6
	E1	2	2	2
	E2	1	1	1
	E3	1	1	1
	E4	2	2	2
	E5	1	1	1
	619	16	16	16
	M416	2	2	2
	M4-1	2	2	2
	M4-2	2	2	2
	M6-1	1	1	1
	E10	2	2	2
	E11	2	2	2
	E12	2	2	2
	M610 M6-1	Used for all sections so quantity not listed in this or other parts lists.		

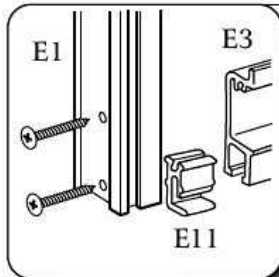

This section is the same for all greenhouse sizes in the range. Lay the parts on the ground as pictured and assemble loosely.

Step 1
Push the plastic door base sliders into the door bottom bar as shown. Screw through the uprights into the bottom bar and the slider.

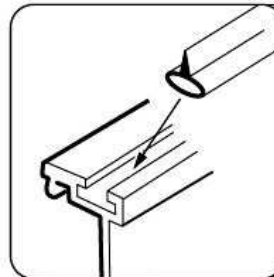

Insert the door seal into the door uprights and trim to length.

Note: Stretching can occur whilst fitting. Allow a few minutes to shrink back before trimming.

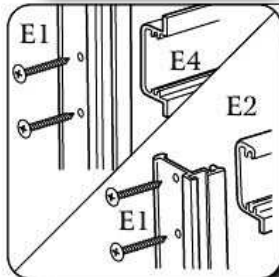

Step 2 & 3
Screw through the uprights into the door middle bars and top bar.

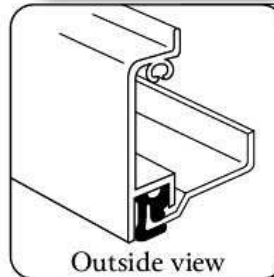

Outside view

Ease the door base slider onto the bottom track.

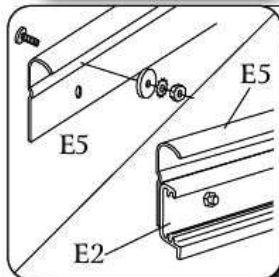

Fix the door running wheels to the runner housing as shown and bolt the housing to the door top rail.

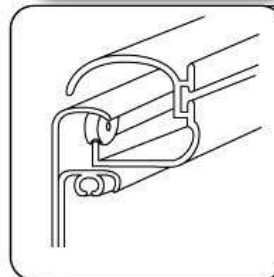

Slide the running wheels onto the top track. Adjust the wheel housing for smooth running of the door.

Pictures are viewed from inside the greenhouse unless stated



Our Help Line provides support and advice to customers of Summer Garden Buildings after ordering. For advice before you buy you can phone us free 7 days a week on 0800 9777828 or visit www.summergardenbuildings.co.uk

F) GREENHOUSE VENT ASSEMBLY

(not applicable to the 6x4 Greenhouse 03)

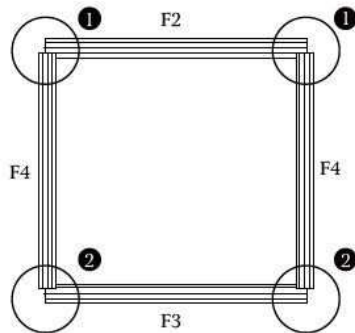
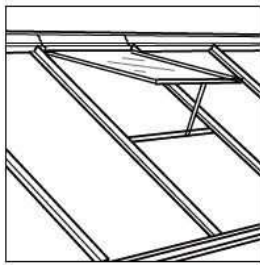

Profile	Code	4x6	6x6	8x6
	F1	0	1	1
	F2	0	1	1
	F3	0	1	1
	F4	0	2	2
	F10	0	1	1
	F12	0	2	2
	66	0	6	6
	M610 M6-1	Used for all sections so quantity not listed in this or other parts lists.		

Notes:

- The assembly is slightly different for glass and polycarbonate glazing.
- Glazing sheets are from separate glazing packs.

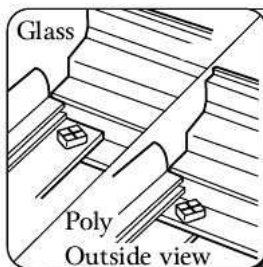

Step 1
Bolt the vent side bars loosely to the vent top bar as shown.

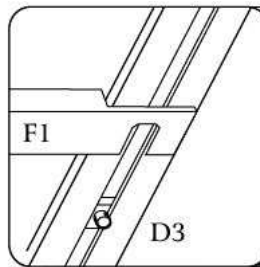

Bolt the vent mounting bar onto the roof bars using the bolts previously inserted (section D, step 5).

Adjust to butt up to the vent and tighten.

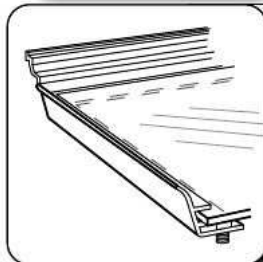

Step 2
Fit nuts and bolts to the bottom ends of the vent sides but do not tighten. Slide the glazing sheet into place. Add the vent bottom bar as shown. Check that the vent is square and tighten all nuts.

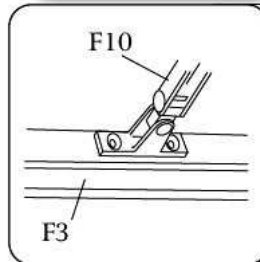

Screw vent stay to vent bottom bar using the pre-drilled holes.

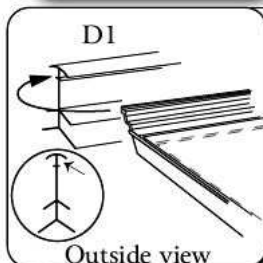

Slide completed vent along the ridge bar until in position.

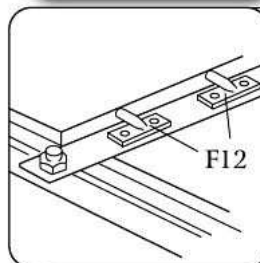



Screw the vent stay catches to the vent mounting bar using the pre-drilled holes.

Pictures are viewed from inside the greenhouse unless stated



Our Help Line provides support and advice to customers of Summer Garden Buildings after ordering. For advice before you buy you can phone us free 7 days a week on 0800 9777828 or visit www.summergardenbuildings.co.uk

G) GREENHOUSE GLAZING

Profile	Code	4x6	6x6	8x6
	G5	1	1	1
	A20	4	4	4



Glazing Bead G5 must be applied to all glazing bars prior to glazing with polycarbonate or glass. Fit to bars as shown and trim to length. Note: Stretching can occur when fitting. Allow a few minutes to shrink back before trimming.



Fit gutter end caps A20 as shown.

The following additional assembly instructions are also available:

GREENHOUSE 01, 02 and 03 GREENHOUSE BASE ASSEMBLY INSTRUCTIONS

GREENHOUSE 01, 02 and 03 GREENHOUSE GLAZING INSTRUCTIONS

Summer Garden Buildings does not guarantee that this is the most recent version of these instructions or that all data has been accurately reproduced. You are advised to refer to the instructions supplied with the product before assembly. If for any reason the instructions are not delivered with the product you are advised to obtain the most recent version before assembly. No guarantee is given regarding the accuracy of these instructions and no liability will be accepted for any errors or inaccuracies.



Our Help Line provides support and advice to customers of Summer Garden Buildings after ordering. For advice before you buy you can phone us free 7 days a week on 0800 9777828 or visit www.summergardenbuildings.co.uk