

Greenhouse Base Assembly Instructions

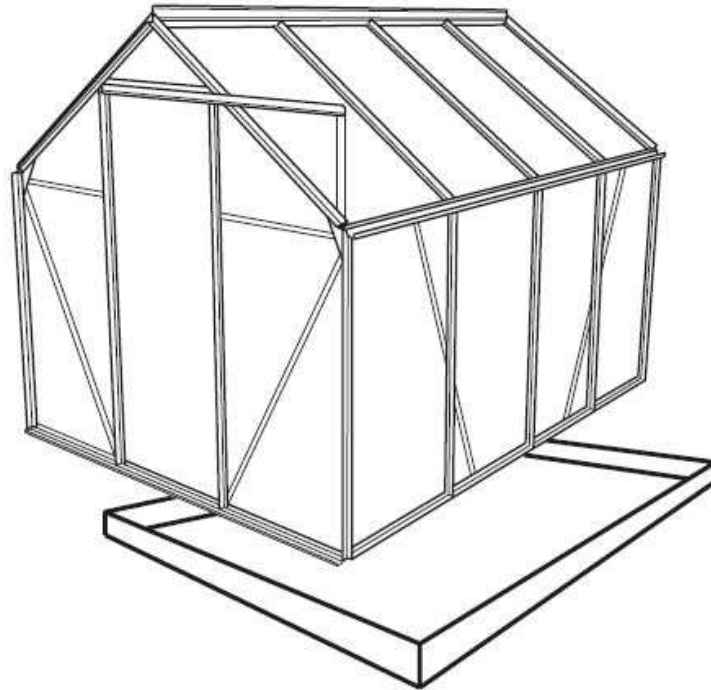

6 x 8 GREENHOUSE 01 BASE ASSEMBLY INSTRUCTIONS

6 x 6 GREENHOUSE 02 BASE ASSEMBLY INSTRUCTIONS

6 x 4 GREENHOUSE 03 BASE ASSEMBLY INSTRUCTIONS

Important









Please read the instructions completely before
starting assembly

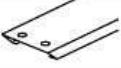

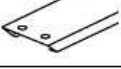
Our Help Line provides support and advice to customers of Summer Garden Buildings after ordering. For advice before you buy you can phone us free 7 days a week on 0800 9777828 or visit www.summergardenbuildings.co.uk

Parts List

Greenhouse Sizes

Profile	4 x 6	6 x 6	8 x 6	Description	Length (mm)	Code
			2	Base Frame Sections	2542	H1-8
	2	4	2	Base Frame Sections	1920	H1-6
	2			Base Frame Sections	1298	H1-4
	4	4	4	Corner Joints		H2
	8	12	14	Frame to base hook clips		H3
	16	16	16	Bolts		M610
	16	16	16	Nuts		M6-1
	14	16	18	Ground Pegs		H4

Introduction

- Construct and secure the base before assembling the greenhouse.
- The base must stand on a firm level surface.
- If mounted on earth, ensure the soil is well compacted and level. Secure the base using the ground pegs provided: these need to be set into pockets of concrete.
- The base can be mounted on slabs provided they are level and are firmly laid.
- A concrete pad can also be used: ensure that it slopes off to the sides to prevent water ingress around the edges.

Tools and equipment required:

- 10mm spanner.
- Spirit level.
- Tape measure.
- Cement and ballast for the fixing pockets.
- Drill, masonry bits, screws and plugs if securing to slabs or a concrete pad.



Our Help Line provides support and advice to customers of Summer Garden Buildings after ordering. For advice before you buy you can phone us free 7 days a week on 0800 9777828 or visit www.summergardenbuildings.co.uk

Section 1

Assembly:

- Bolt the corner joints (H2) to the frames as shown. **Fig A.**
- Lay the base in position and check with a spirit level that it is level all round, adjusting as necessary.
- Check that the base is square before securing to the ground. This is easily done by measuring the diagonals: these will be the same length when the base is square.

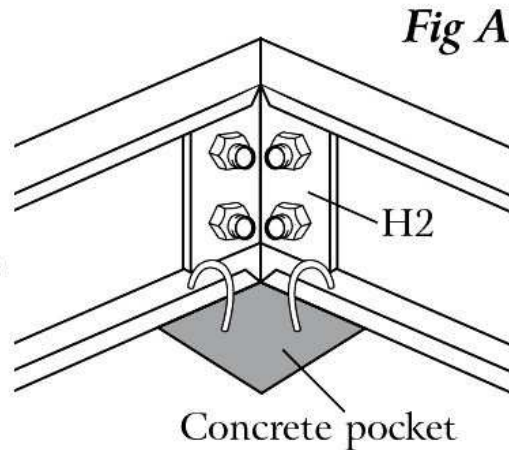

Section 2

Securing the base on soil:

- Dig holes for concrete pockets. These should be deeper than the length of the ground pegs and need to be positioned at each corner and also adjacent to each greenhouse upright.
- Apply 2 pegs at the corners and one peg elsewhere next to an upright. Ensure the pegs are inserted at an angle, as shown. **Fig B.**

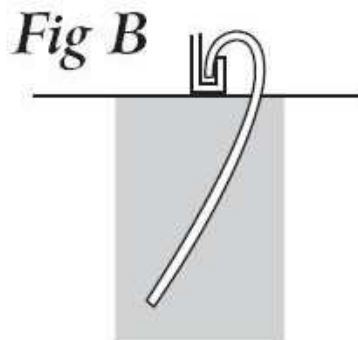

Our Help Line provides support and advice to customers of Summer Garden Buildings after ordering. For advice before you buy you can phone us free 7 days a week on 0800 9777828 or visit www.summergardenbuildings.co.uk

Section 3

Securing the base on concrete or slabs:

- Drill through the base frame as illustrated. **Fig C.**
- Drill and plug the concrete or slab, ensuring that the hole is made far enough away from the edge to prevent splitting.

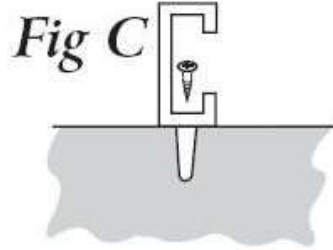

Section 4

Mounting the greenhouse:

- Wait until all concrete is fully set before mounting the greenhouse on the base.
- Apply the clips (H3) to the sides, including the corners, and at the ends.
- Undo the nuts at the bottom of the greenhouse corners & vertical glazing bars. Hook clips under base rim and over the bolts before re-attaching and tightening the nuts.
- Check that the greenhouse is firmly secured and all nuts are tightened.

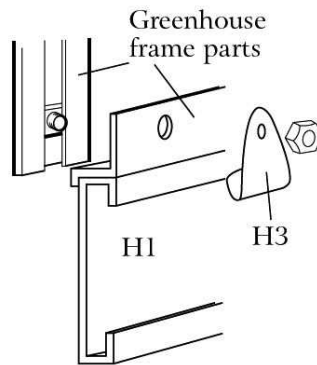

Summer Garden Buildings does not guarantee that this is the most recent version of these instructions or that all data has been accurately reproduced. You are advised to refer to the instructions supplied with the product before assembly. If for any reason the instructions are not delivered with the product you are advised to obtain the most recent version before assembly. No guarantee is given regarding the accuracy of these instructions and no liability will be accepted for any errors or inaccuracies.



Our Help Line provides support and advice to customers of Summer Garden Buildings after ordering. For advice before you buy you can phone us free 7 days a week on 0800 9777828 or visit www.summergardenbuildings.co.uk